

Biesheuvel Autosport
Installation Number

30340

SAFETY CAGE SPECIFICATION

Biesheuvel Autosport is a  certified company for installations off roll-bars
This roll bar is built in under Annexe J artikel 253 self construction

Safety Cage Manufacturer	Biesheuvel Autosport
Address	Rijksweg 37 4255 GE Nieuwendijk Netherlands
Phone n° + Email	0031 183 403400 info@biesheuvel.nl

The structure shown on this form is manufactured for the following vehicle:

Make	DATSUN	Model	240 Z	Year/Model Identifier	1972
Vehicle Homologation Number(s)* *if applicable		N/A			

Drawing of front ¾ view of the Complete Structure showing the location of the identification plate

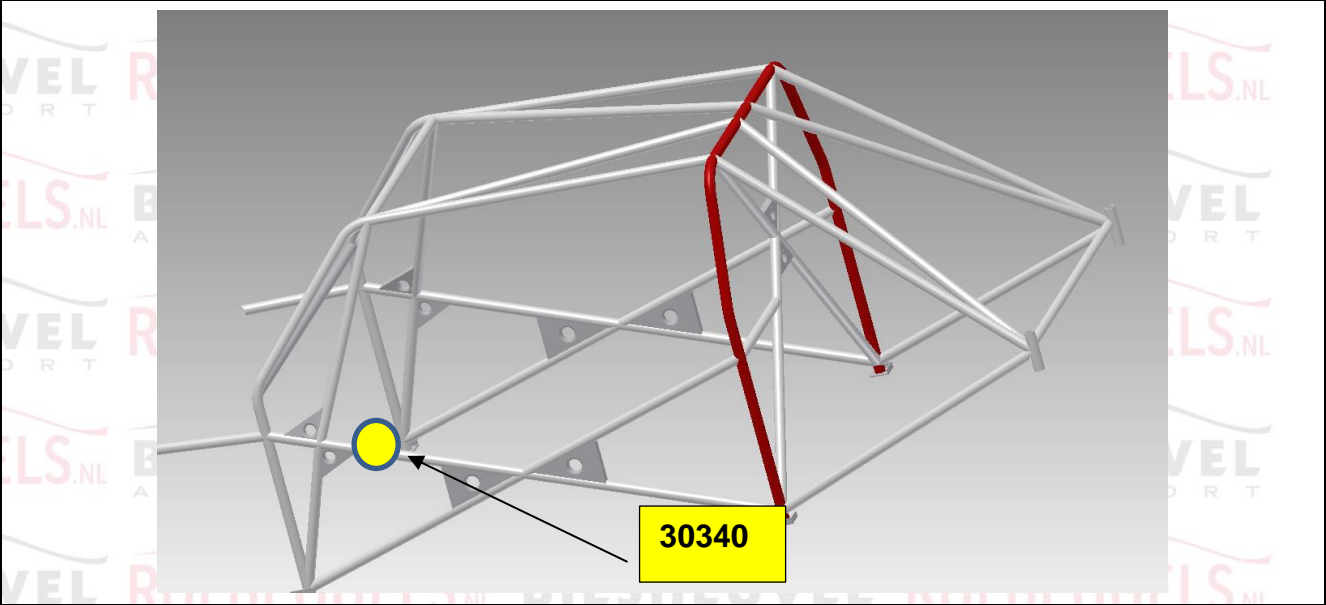

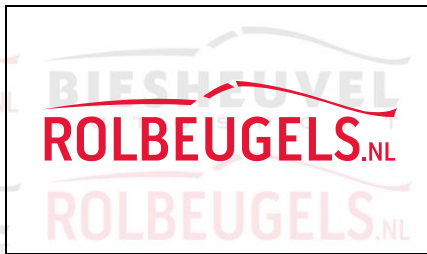
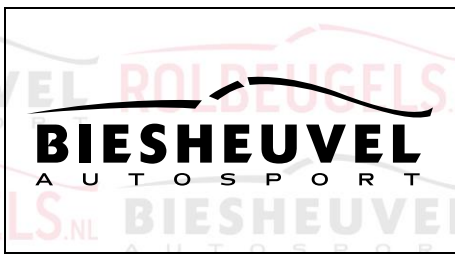

Biesheuvel Autosport
Installation Number

30340

DETAILS OF STRUCTURE

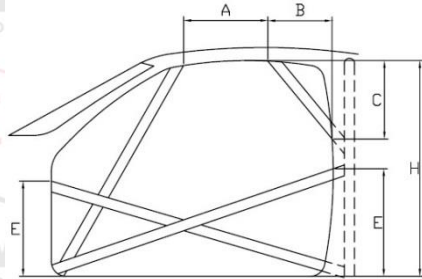

A = mm B = mm

C = mm E = mm

H = mm (E is highest figure only)

All Dimensions ± 5mm

Method of attachment to Body Shell	Welded
Weight of Safety Cage, inc. fastenings	55 kg

LABELLED DRAWING OF THE SAFETY CAGE STRUCTURE SHOWING ALL TUBING DIMENSIONS

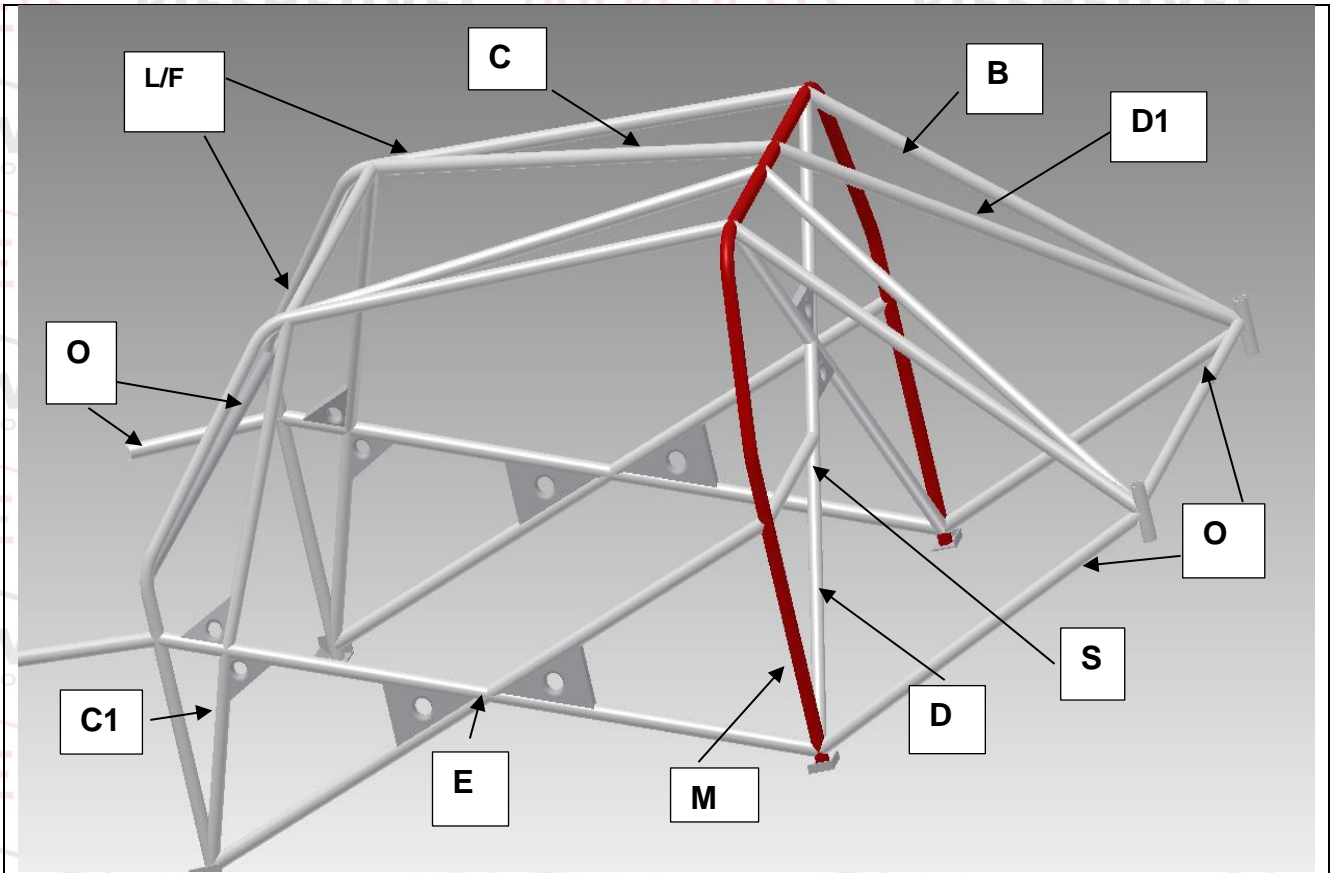

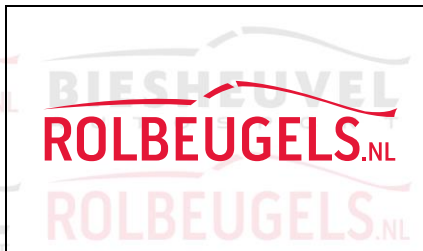

Biesheuvel Autosport
Installation Number

30340

All Dimensions $\pm 0.1\text{mm}$		Show location of each type on drawing			
Tube / Member	Label	Grade of Steel	External Diameter (OD)	Wall Thickness	Min. Tensile Strength
Main Rollbar	<u>M</u>	<u>E235EN/10305-1</u>	45.0 mm	2.5 Mm	480 N/mm ²
Front/Lateral Rollbar	<u>L/F</u>	<u>E235EN/10305-1</u>	40.0 mm	2.0 Mm	480 N/mm ²
Backstays	<u>B</u>	<u>E235EN/10305-1</u>	40.0 mm	2.0 Mm	480 N/mm ²
Main rollbar Diagonal members	<u>D</u>	<u>E235EN/10305-1</u>	40.0 mm	2.0 Mm	480 N/mm ²
Backstay Diagonal members	<u>D1</u>	<u>E2135EN/10305-1</u>	40.0 mm	2.0 Mm	480 N/mm ²
Roof Reinforcements	<u>C</u>	<u>E235EN/10305-1</u>	40.0 mm	2.0 Mm	480 N/mm ²
Doorbars	<u>E</u>	<u>E235EN/10305-1</u>	40.0 mm	2.0 Mm	480 N/mm ²
Windscreen Pillar Reinforcements	<u>C1</u>	<u>E235EN/10305-1</u>	40.0 mm	2.0 Mm	480 N/mm ²
Harness Bar	<u>S</u>	<u>E235EN/10305-1</u>	40.0 mm	2.0 Mm	480 N/mm ²
OPTINAL TUBES	<u>O</u>	<u>E235EN/10305-1</u>	40.0 mm	2.0 Mm	480 N/mm ²
OPTINAL TUBES			mm	Mm	N/mm ²
			mm	Mm	N/mm ²
			mm	Mm	N/mm ²
			mm	mm	N/mm ²
			mm	mm	N/mm ²
Total length of all tubes < 40 mm OD			mm	15 m maximum	

PHOTO 1
FRONT ¾ VIEW OF CAGE



PHOTO 2
REAR ¾ VIEW OF CAGE



PHOTO 3
VIEW FROM SIDE OF CAR



PHOTO 4
MAIN ROLLBAR TO FLOOR ATTACHMENT



PHOTO 5
REAR BACKSTAY TO BODYSHELL ATTACHMENT



PHOTO 6
FRONT ROLLBAR TO FLOOR ATTACHMENT

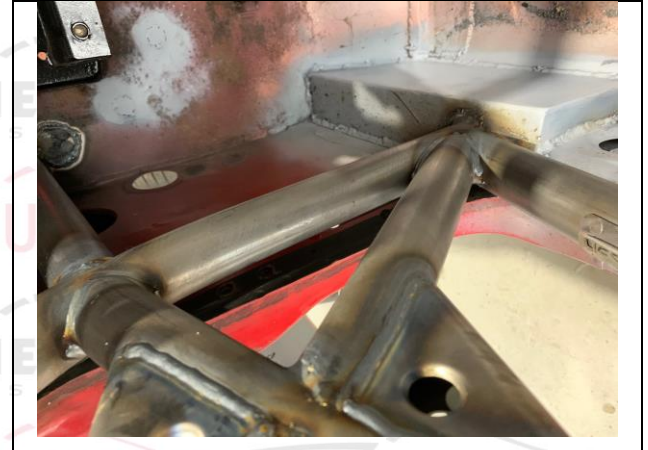

PHOTO 7
FRONT ROLLBAR TO "A" PILLAR ATTACHMENT



PHOTO 8
MAIN ROLLBAR TO "B" PILLAR ATTACHMENT



PHOTO 9
ATTACHMENT TO FRONT SUSPENSION



PHOTO
Chassis Identification Number

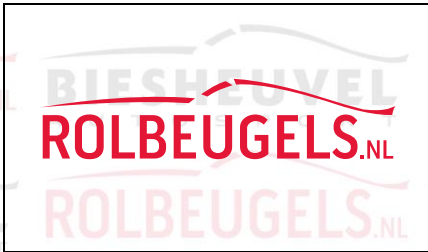
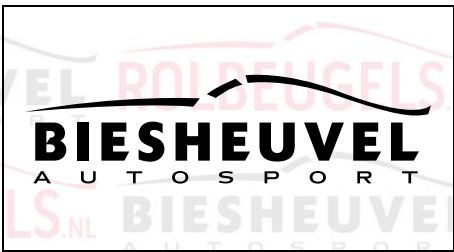

PHOTO 10
ANTI-INTRUSION DOORBAR - DRIVER



PHOTO 11
ANTI-INTRUSION DOORBAR – CO-DRIVER





Biesheuvvel Autosport
Installation Number

30340

PHOTO 12
SHOULDER HARNESS ATTACHMENT - DRIVER

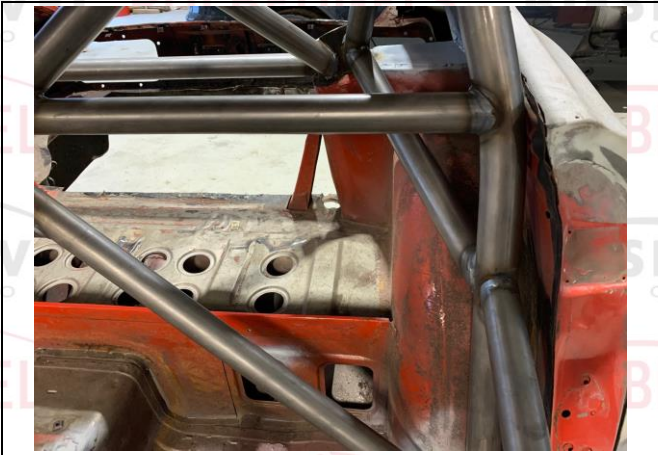

PHOTO 13
SHOULDER HARNESS ATTACHMENT - CO DRIVER



PHOTO 14
LOCATION OF IDENTIFICATION PLATE



PHOTO 16
DETAILS OF IDENTIFICATION PLATE

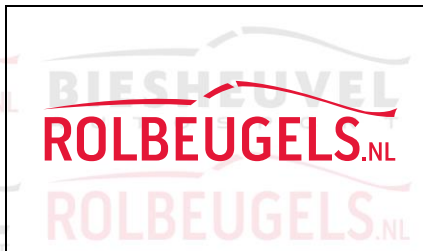

PHOTO 17
OTHER DETAILS OF CAGE



PHOTO 18
OTHER DETAILS OF CAGE





Biesheuvel Autosport
Installation Number

30340

V.I.N. or Chassis Identification Number	
Safety cage identification Number	30340

MANUFACTURER'S DECLARATION AND DETAILS:

I declare that the Safety Cage Structure described on this form and fitted to the vehicle described above:

- was constructed and installed in accordance with the specifications and design shown herein.
- has been manufactured so that all aspects of the Safety Cage design, including configuration and strength requirements and welded and demountable joints and mountings, will be in conformity with the requirements of the FIA Homologation Regulations for Safety Cages.
- has been identified by an engraved plate bearing the name or logo of the manufacturer, (Biesheuvel Autosport)

Manufacturer's Name	<u>Biesheuvel Autosport</u>	<p>Insert Manufacturer Stamp here</p>
Address	<u>Rijksweg 37</u> <u>4255 GE Nieuwendijk</u> <u>Netherlands</u>	
Phone n° + Email	<u>0031 183 403400</u> <u>info@biesheuvel.nl</u>	
Signature:	Insert signature here	
Name of Signatory#:	<u>N Biesheuvel</u>	

MANUFACTURER'S AGENT: (For Safety Cages installed by an Agent)

The following Agent is authorised to act on the manufacturer's behalf to install this Safety Cage design.

Agent's Name	<u>GB Metaal Techniek</u>
Address	<u>Bredesteeg 2</u> <u>4255 GH Nieuwendijk</u> <u>Netherlands</u>
Phone n° + Email	<u>0031 622607952</u> <u>info@rolbeugels.nl</u>

Instructions to the installer of the Safety Cage

--

